

AIR-FELT BAFFLE 1200x150x30

Baffle Collection

Feltra models are easy to install, lightweight, and can be installed quickly to transform large volumes into linear ceiling systems. Baffle delivers tailor-made acoustic solutions that offer an adjustable gap between felt baffles and various dimensions. On request, it allows different thickness options and customizable designs.

SPECIFICATION

- Composition: 100 % polyester (recycled PET appx. 50 %)
- Material Weight: 6mm: 1300g /m² (+/- 5 %)
- Material Thickness: 6mm Natural & Mandarin colors (+/- 10 %)
- Product Weight: Natural: kg per pcs. (+/- %5)
Mandarin: kg per pcs. (+/- %5)

PERFORMANCE

- Fire Rates: B, S1, d0 (EN-13501)
- Light fastness: 6+ (ISO-105 B02)
- Health : 99.9 %
- Antibacterial (ISO-20743)
- Formaldehyde-free (ISO-14184)
- Moisture Absorption: >0.03 % by weight (50°C/122°F at 90% relative humidity)
- Thermal insulating: 0,040 W/mK
- Abrasion: EN ISO 12947 / Performance 'A'

KEY FEATURES & BENEFITS

- Available in 7 Natural colors & 34 Mandarin colors.
- Highly durable providing long-term stability and performance.
- Safe, non-toxic, non-irritant & without red list chemical binders.
- Recycled and recyclable.
- 10 years warranty.

CARE

- Easy to clean with a damp cloth or vacuum cleaner.
- Indoor use only.

INSTALLATION

- Designed for easy assembly free hanging installation method with adjustable ceiling mount units.

Dimensions (mm):

L: 1200mm
H: 150mm
Thickness:
30mm

MOQ: Minimum order quantity is 8 pcs in each colour.

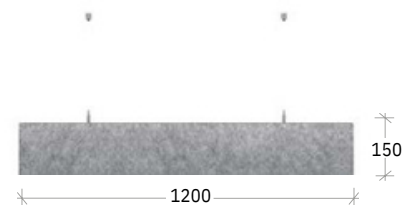
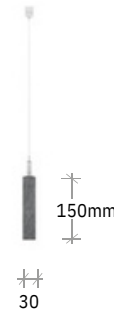
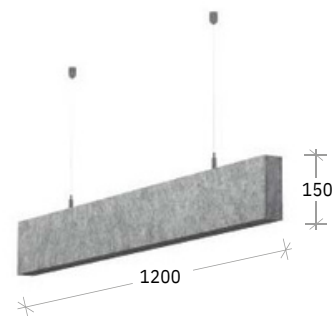

HEAD OFFICE

Westward House, Camberley, GU15 3DB | T: +44 (0) 1276 686175 | E: info@nogreyarea.co.uk

MENA REGION HQ

PO Box 449839, Dubai, UAE | T: +971 (0) 433 38300 | E: info@nogreyarea.me | www.no-grey-area.com

NGA

AIR-FELT BAFFLE 1200x150x40

Baffle Collection

Feltra models are easy to install, lightweight, and can be installed quickly to transform large volumes into linear ceiling systems. Baffle delivers tailor-made acoustic solutions that offer an adjustable gap between felt baffles and various dimensions. On request, it allows different thickness options and customizable designs.

SPECIFICATION

- Composition: 100 % polyester (recycled PET appx. 50 %)
- Material Weight: 6mm: 1300g /m² (+/- 5 %)
- Material Thickness: 6mm Natural & Mandarin colors (+/- 10 %)
- Product Weight: Natural: kg per pcs. (+/- %5)
Mandarin: kg per pcs. (+/- %5)

PERFORMANCE

- Fire Rates: B, S1, d0 (EN-13501)
- Light fastness: 6+ (ISO-105 B02)
- Health : 99.9 %
- Antibacterial (ISO-20743)
- Formaldehyde-free (ISO-14184)
- Moisture Absorption: >0.03 % by weight (50°C/122°F at 90% relative humidity)
- Thermal insulating: 0,040 W/mK
- Abrasion: EN ISO 12947 / Performance 'A'

KEY FEATURES & BENEFITS

- Available in 7 Natural colors & 34 Mandarin colors.
- Highly durable providing long-term stability and performance.
- Safe, non-toxic, non-irritant & without red list chemical binders.
- Recycled and recyclable.
- 10 years warranty.

CARE

- Easy to clean with a damp cloth or vacuum cleaner.
- Indoor use only.

INSTALLATION

- Designed for easy assembly free hanging installation method with adjustable ceiling mount units.

DIMENSIONS (MM):

L: 1200mm
H: 150mm
Thickness: 40mm

MOQ: Minimum order quantity is 8 pcs in each colour.

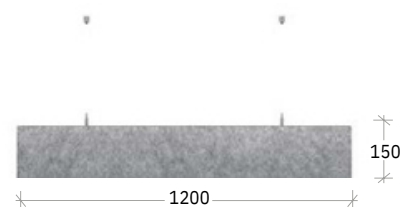
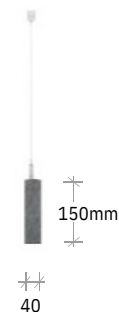
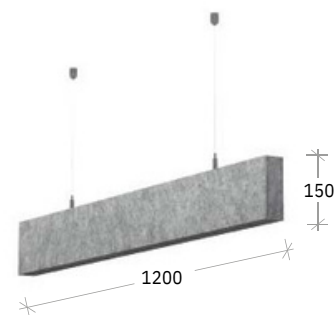

HEAD OFFICE

Westward House, Camberley, GU15 3DB | T: +44 (0) 1276 686175 | E: info@nogreyarea.co.uk

MENA REGION HQ

PO Box 449839, Dubai, UAE | T: +971 (0) 433 38300 | E: info@nogreyarea.me | www.no-grey-area.com

NGA

AIR-FELT BAFFLE 1200x150x50

Baffle Collection

Feltra models are easy to install, lightweight, and can be installed quickly to transform large volumes into linear ceiling systems. Baffle delivers tailor-made acoustic solutions that offer an adjustable gap between felt baffles and various dimensions. On request, it allows different thickness options and customizable designs.

SPECIFICATION

- Composition: 100 % polyester (recycled PET appx. 50 %)
- Material Weight: 6mm: 1300g /m² (+/- 5 %)
- Material Thickness: 6mm Natural & Mandarin colors (+/- 10 %)
- Product Weight: Natural: kg per pcs. (+/- %5)
Mandarin: kg per pcs. (+/- %5)

DIMENSIONS (MM):

L: 1200mm
H: 150mm
Thickness:
50mm

MOQ: Minimum
order quantity is 6
pcs in each colour.

PERFORMANCE

- Fire Rates: B, S1, d0 (EN-13501)
- Light fastness: 6+ (ISO-105 B02)
- Health : 99.9 %
- Antibacterial (ISO-20743)
- Formaldehyde-free (ISO-14184)
- Moisture Absorption: >0.03 % by weight (50°C/122°F at 90% relative humidity)
- Thermal insulating: 0,040 W/mK
- Abrasion: EN ISO 12947 / Performance 'A'

KEY FEATURES & BENEFITS

- Available in 7 Natural colors & 34 Mandarin colors.
- Highly durable providing long-term stability and performance.
- Safe, non-toxic, non-irritant & without red list chemical binders.
- Recycled and recyclable.
- 10 years warranty.

CARE

- Easy to clean with a damp cloth or vacuum cleaner.
- Indoor use only.

INSTALLATION

- Designed for easy assembly free hanging installation method with adjustable ceiling mount units.

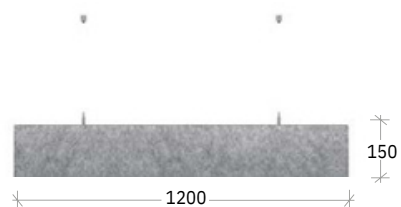
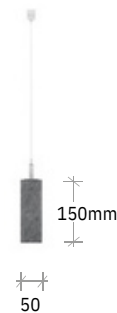
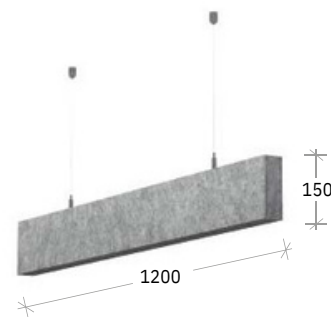

HEAD OFFICE

Westward House, Camberley, GU15 3DB | T: +44 (0) 1276 686175 | E: info@nogreyarea.co.uk

MENA REGION HQ

PO Box 449839, Dubai, UAE | T: +971 (0) 433 38300 | E: info@nogreyarea.me | www.no-grey-area.com

NGA

AIR-FELT BAFFLE 1200x200x30

Baffle Collection

Feltra models are easy to install, lightweight, and can be installed quickly to transform large volumes into linear ceiling systems. Baffle delivers tailor-made acoustic solutions that offer an adjustable gap between felt baffles and various dimensions. On request, it allows different thickness options and customizable designs.

SPECIFICATION

- Composition: 100 % polyester (recycled PET appx. 50 %)
- Material Weight: 6mm: 1300g /m² (+/- 5 %)
- Material Thickness: 6mm Natural & Mandarin colors (+/- 10 %)
- Product Weight: Natural: kg per pcs. (+/- %5)
Mandarin: kg per pcs. (+/- %5)

PERFORMANCE

- Fire Rates: B, S1, d0 (EN-13501)
- Light fastness: 6+ (ISO-105 B02)
- Health : 99.9 %
- Antibacterial (ISO-20743)
- Formaldehyde-free (ISO-14184)
- Moisture Absorption: >0.03 % by weight (50°C/122°F at 90% relative humidity)
- Thermal insulating: 0,040 W/mK
- Abrasion: EN ISO 12947 / Performance 'A'

KEY FEATURES & BENEFITS

- Available in 7 Natural colors & 34 Mandarin colors.
- Highly durable providing long-term stability and performance.
- Safe, non-toxic, non-irritant & without red list chemical binders.
- Recycled and recyclable.
- 10 years warranty.

CARE

- Easy to clean with a damp cloth or vacuum cleaner.
- Indoor use only.

INSTALLATION

- Designed for easy assembly free hanging installation method with adjustable ceiling mount units.

DIMENSIONS (MM):

L: 1200mm
H: 200mm
Thickness:
30mm

MOQ: Minimum order quantity is 5 pcs in each colour.

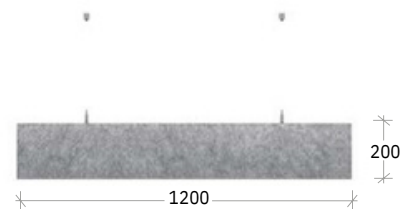
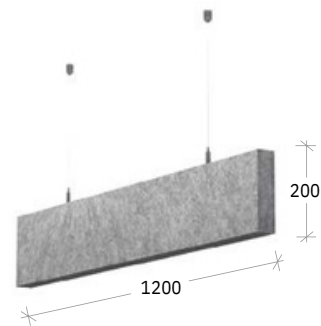

HEAD OFFICE

Westward House, Camberley, GU15 3DB | T: +44 (0) 1276 686175 | E: info@nogreyarea.co.uk

MENA REGION HQ

PO Box 449839, Dubai, UAE | T: +971 (0) 433 38300 | E: info@nogreyarea.me | www.no-grey-area.com

NGA

AIR-FELT BAFFLE 1200x200x40

Feltra models are easy to install, lightweight, and can be installed quickly to transform large volumes into linear ceiling systems. Baffle delivers tailor-made acoustic solutions that offer an adjustable gap between felt baffles and various dimensions. On request, it allows different thickness options and customizable designs.

SPECIFICATION

- Composition: 100 % polyester (recycled PET appx. 50 %)
- Material Weight: 6mm: 1300g /m² (+/- 5 %)
- Material Thickness: 6mm Natural & Mandarin colors (+/- 10 %)
- Product Weight: Natural: kg per pcs. (+/- %5)
Mandarin: kg per pcs. (+/- %5)

PERFORMANCE

- Fire Rates: B, S1, d0 (EN-13501)
- Light fastness: 6+ (ISO-105 B02)
- Health : 99.9 %
- Antibacterial (ISO-20743)
- Formaldehyde-free (ISO-14184)
- Moisture Absorption: >0.03 % by weight (50°C/122°F at 90% relative humidity)
- Thermal insulating: 0,040 W/mK
- Abrasion: EN ISO 12947 / Performance 'A'

KEY FEATURES & BENEFITS

- Available in 7 Natural colors & 34 Mandarin colors.
- Highly durable providing long-term stability and performance.
- Safe, non-toxic, non-irritant & without red list chemical binders.
- Recycled and recyclable.
- 10 years warranty.

CARE

- Easy to clean with a damp cloth or vacuum cleaner.
- Indoor use only.

INSTALLATION

- Designed for easy assembly free hanging installation method with adjustable ceiling mount units.

DIMENSIONS (MM):

L: 1200mm
H: 200mm
Thickness:
40mm

MOQ: Minimum order quantity is 6 pcs in each colour.

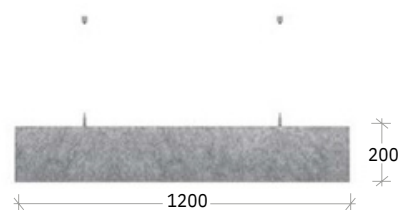
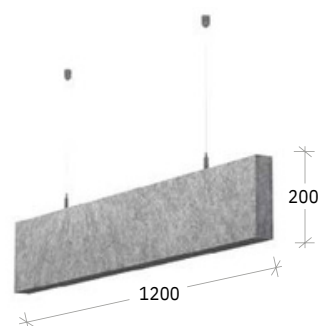

HEAD OFFICE

Westward House, Camberley, GU15 3DB | T: +44 (0) 1276 686175 | E: info@nogreyarea.co.uk

MENA REGION HQ

PO Box 449839, Dubai, UAE | T: +971 (0) 433 38300 | E: info@nogreyarea.me | www.no-grey-area.com

NGA

AIR-FELT BAFFLE 1200x200x50

Baffle Collection

Feltra models are easy to install, lightweight, and can be installed quickly to transform large volumes into linear ceiling systems. Baffle delivers tailor-made acoustic solutions that offer an adjustable gap between felt baffles and various dimensions. On request, it allows different thickness options and customizable designs.

SPECIFICATION

- Composition: 100 % polyester (recycled PET appx. 50 %)
- Material Weight: 6mm: 1300g /m² (+/- 5 %)
- Material Thickness: 6mm Natural & Mandarin colors (+/- 10 %)
- Product Weight: Natural: kg per pcs. (+/- %5)
Mandarin: kg per pcs. (+/- %5)

PERFORMANCE

- Fire Rates: B, S1, d0 (EN-13501)
- Light fastness: 6+ (ISO-105 B02)
- Health : 99.9 %
- Antibacterial (ISO-20743)
- Formaldehyde-free (ISO-14184)
- Moisture Absorption: >0.03 % by weight (50°C/122°F at 90% relative humidity)
- Thermal insulating: 0,040 W/mK
- Abrasion: EN ISO 12947 / Performance 'A'

KEY FEATURES & BENEFITS

- Available in 7 Natural colors & 34 Mandarin colors.
- Highly durable providing long-term stability and performance.
- Safe, non-toxic, non-irritant & without red list chemical binders.
- Recycled and recyclable.
- 10 years warranty.

CARE

- Easy to clean with a damp cloth or vacuum cleaner.
- Indoor use only.

INSTALLATION

- Designed for easy assembly free hanging installation method with adjustable ceiling mount units.

DIMENSIONS (MM):

L: 1200mm
H: 200mm
Thickness: 50mm

MOQ: Minimum order quantity is 6 pcs in each colour.

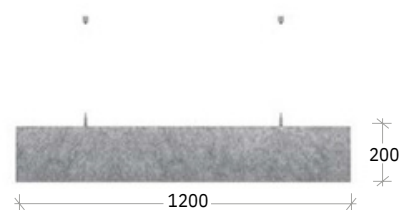
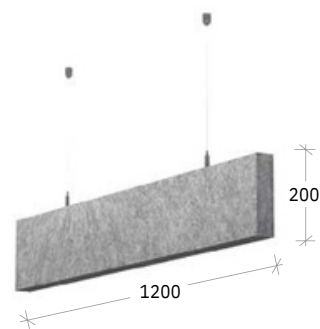

HEAD OFFICE

Westward House, Camberley, GU15 3DB | T: +44 (0) 1276 686175 | E: info@nogreyarea.co.uk

MENA REGION HQ

PO Box 449839, Dubai, UAE | T: +971 (0) 433 38300 | E: info@nogreyarea.me | www.no-grey-area.com

NGA

AIR-FELT BAFFLE 1200x300x30

Baffle Collection

Feltra models are easy to install, lightweight, and can be installed quickly to transform large volumes into linear ceiling systems. Baffle delivers tailor-made acoustic solutions that offer an adjustable gap between felt baffles and various dimensions. On request, it allows different thickness options and customizable designs.

SPECIFICATION

- Composition: 100 % polyester (recycled PET appx. 50 %)
- Material Weight: 6mm: 1300g /m² (+/- 5 %)
- Material Thickness: 6mm Natural & Mandarin colors (+/- 10 %)
- Product Weight: Natural: kg per pcs. (+/- %5)
Mandarin: kg per pcs. (+/- %5)

PERFORMANCE

- Fire Rates: B, S1, d0 (EN-13501)
- Light fastness: 6+ (ISO-105 B02)
- Health : 99.9 %
- Antibacterial (ISO-20743)
- Formaldehyde-free (ISO-14184)
- Moisture Absorption: >0.03 % by weight (50°C/122°F at 90% relative humidity)
- Thermal insulating: 0,040 W/mK
- Abrasion: EN ISO 12947 / Performance 'A'

KEY FEATURES & BENEFITS

- Available in 7 Natural colors & 34 Mandarin colors.
- Highly durable providing long-term stability and performance.
- Safe, non-toxic, non-irritant & without red list chemical binders.
- Recycled and recyclable.
- 10 years warranty.

CARE

- Easy to clean with a damp cloth or vacuum cleaner.
- Indoor use only.

INSTALLATION

- Designed for easy assembly free hanging installation method with adjustable ceiling mount units.

DIMENSIONS (MM):

L: 1200mm
H: 300mm
Thickness:
30mm

MOQ: Minimum
order quantity is 4
pcs in each colour.

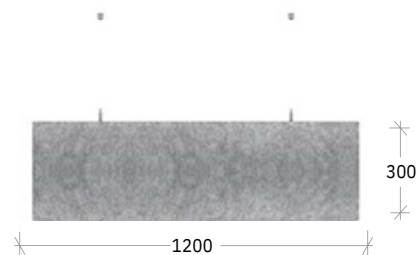
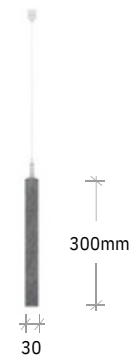
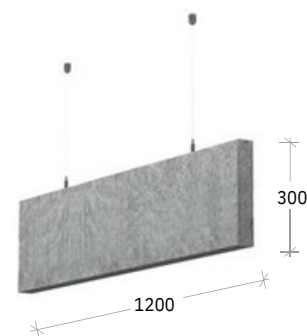

HEAD OFFICE

Westward House, Camberley, GU15 3DB | T: +44 (0) 1276 686175 | E: info@nogreyarea.co.uk

MENA REGION HQ

PO Box 449839, Dubai, UAE | T: +971 (0) 433 38300 | E: info@nogreyarea.me | www.no-grey-area.com

NGA

AIR-FELT BAFFLE 1200x300x40

Baffle Collection

Feltra models are easy to install, lightweight, and can be installed quickly to transform large volumes into linear ceiling systems. Baffle delivers tailor-made acoustic solutions that offer an adjustable gap between felt baffles and various dimensions. On request, it allows different thickness options and customizable designs.

SPECIFICATION

- Composition: 100 % polyester (recycled PET appx. 50 %)
- Material Weight: 6mm: 1300g /m² (+/- 5 %)
- Material Thickness: 6mm Natural & Mandarin colors (+/- 10 %)
- Product Weight: Natural: kg per pcs. (+/- %5)
Mandarin: kg per pcs. (+/- %5)

DIMENSIONS (MM):

L: 1200mm
H: 300mm
Thickness:
40mm

MOQ: Minimum
order quantity is 4
pcs in each colour.

PERFORMANCE

- Fire Rates: B, S1, d0 (EN-13501)
- Light fastness: 6+ (ISO-105 B02)
- Health : 99.9 %
- Antibacterial (ISO-20743)
- Formaldehyde-free (ISO-14184)
- Moisture Absorption: >0.03 % by weight (50°C/122°F at 90% relative humidity)
- Thermal insulating: 0,040 W/mK
- Abrasion: EN ISO 12947 / Performance 'A'

KEY FEATURES & BENEFITS

- Available in 7 Natural colors & 34 Mandarin colors.
- Highly durable providing long-term stability and performance.
- Safe, non-toxic, non-irritant & without red list chemical binders.
- Recycled and recyclable.
- 10 years warranty.

CARE

- Easy to clean with a damp cloth or vacuum cleaner.
- Indoor use only.

INSTALLATION

- Designed for easy assembly free hanging installation method with adjustable ceiling mount units.

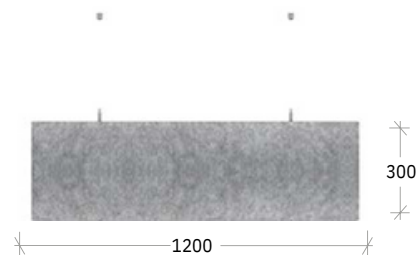
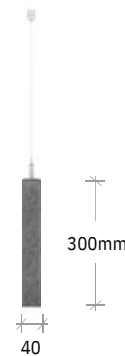
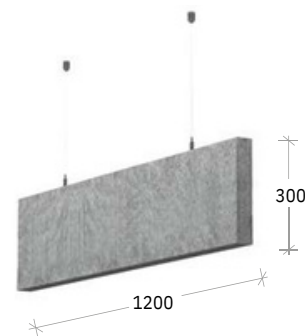

HEAD OFFICE

Westward House, Camberley, GU15 3DB | T: +44 (0) 1276 686175 | E: info@nogreyarea.co.uk

MENA REGION HQ

PO Box 449839, Dubai, UAE | T: +971 (0) 433 38300 | E: info@nogreyarea.me | www.no-grey-area.com

NGA

AIR-FELT BAFFLE 1200x300x50

Baffle Collection

Feltra models are easy to install, lightweight, and can be installed quickly to transform large volumes into linear ceiling systems. Baffle delivers tailor-made acoustic solutions that offer an adjustable gap between felt baffles and various dimensions. On request, it allows different thickness options and customizable designs.

SPECIFICATION

- Composition: 100 % polyester (recycled PET appx. 50 %)
- Material Weight: 6mm: 1300g /m² (+/- 5 %)
- Material Thickness: 6mm Natural & Mandarin colors (+/- 10 %)
- Product Weight: Natural: kg per pcs. (+/- %5)
Mandarin: kg per pcs. (+/- %5)

DIMENSIONS (MM):

L: 1200mm
H: 300mm
Thickness:
50mm

MOQ: Minimum
order quantity is 4
pcs in each colour.

PERFORMANCE

- Fire Rates: B, S1, d0 (EN-13501)
- Light fastness: 6+ (ISO-105 B02)
- Health : 99.9 %
- Antibacterial (ISO-20743)
- Formaldehyde-free (ISO-14184)
- Moisture Absorption: >0.03 % by weight (50°C/122°F at 90% relative humidity)
- Thermal insulating: 0,040 W/mK
- Abrasion: EN ISO 12947 / Performance 'A'

KEY FEATURES & BENEFITS

- Available in 7 Natural colors & 34 Mandarin colors.
- Highly durable providing long-term stability and performance.
- Safe, non-toxic, non-irritant & without red list chemical binders.
- Recycled and recyclable.
- 10 years warranty.

CARE

- Easy to clean with a damp cloth or vacuum cleaner.
- Indoor use only.

INSTALLATION

- Designed for easy assembly free hanging installation method with adjustable ceiling mount units.

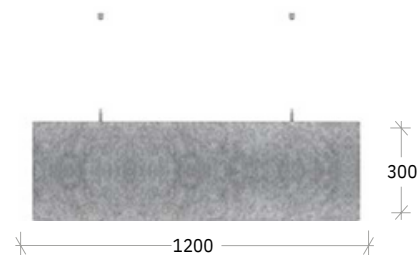
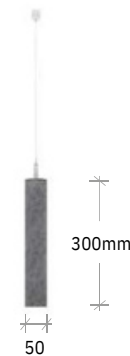
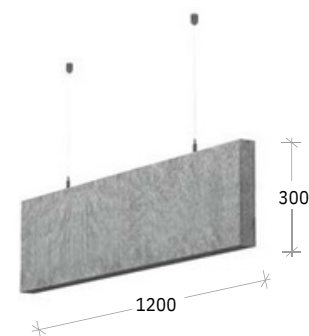

HEAD OFFICE

Westward House, Camberley, GU15 3DB | T: +44 (0) 1276 686175 | E: info@nogreyarea.co.uk

MENA REGION HQ

PO Box 449839, Dubai, UAE | T: +971 (0) 433 38300 | E: info@nogreyarea.me | www.no-grey-area.com

NGA

AIR-FELT BAFFLE 1800x150x30

Baffle Collection

Feltra models are easy to install, lightweight, and can be installed quickly to transform large volumes into linear ceiling systems. Baffle delivers tailor-made acoustic solutions that offer an adjustable gap between felt baffles and various dimensions. On request, it allows different thickness options and customizable designs.

SPECIFICATION

- Composition: 100 % polyester (recycled PET appx. 50 %)
- Material Weight: 6mm: 1300g /m² (+/- 5 %)
- Material Thickness: 6mm Natural & Mandarin colors (+/- 10 %)
- Product Weight: Natural: kg per pcs. (+/- %5)
Mandarin: kg per pcs. (+/- %5)

DIMENSIONS (MM):

- L: 1800mm
- H: 150mm
- Thickness: 30mm
- MOQ: Minimum order quantity is 4 pcs in each colour.

PERFORMANCE

- Fire Rates: B, S1, d0 (EN-13501)
- Light fastness: 6+ (ISO-105 B02)
- Health : 99.9 %
- Antibacterial (ISO-20743)
- Formaldehyde-free (ISO-14184)
- Moisture Absorption: >0.03 % by weight (50°C/122°F at 90% relative humidity)
- Thermal insulating: 0,040 W/mK
- Abrasion: EN ISO 12947 / Performance 'A'

KEY FEATURES & BENEFITS

- Available in 7 Natural colors & 34 Mandarin colors.
- Highly durable providing long-term stability and performance.
- Safe, non-toxic, non-irritant & without red list chemical binders.
- Recycled and recyclable.
- 10 years warranty.

CARE

- Easy to clean with a damp cloth or vacuum cleaner.
- Indoor use only.

INSTALLATION

- Designed for easy assembly free hanging installation method with adjustable ceiling mount units.

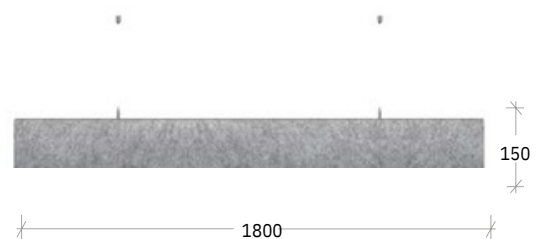
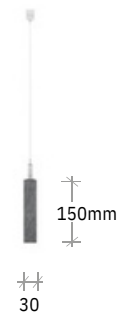
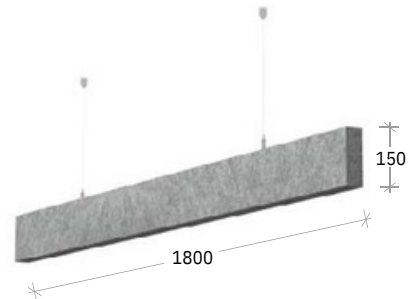

HEAD OFFICE

Westward House, Camberley, GU15 3DB | T: +44 (0) 1276 686175 | E: info@nogreyarea.co.uk

MENA REGION HQ

PO Box 449839, Dubai, UAE | T: +971 (0) 433 38300 | E: info@nogreyarea.me | www.no-grey-area.com

NGA

AIR-FELT BAFFLE 1800x150x40

Baffle Collection

Feltra models are easy to install, lightweight, and can be installed quickly to transform large volumes into linear ceiling systems. Baffle delivers tailor-made acoustic solutions that offer an adjustable gap between felt baffles and various dimensions. On request, it allows different thickness options and customizable designs.

SPECIFICATION

- Composition: 100 % polyester (recycled PET appx. 50 %)
- Material Weight: 6mm: 1300g /m² (+/- 5 %)
- Material Thickness: 6mm Natural & Mandarin colors (+/- 10 %)
- Product Weight: Natural: kg per pcs. (+/- %5)
Mandarin: kg per pcs. (+/- %5)

DIMENSIONS (MM):

L: 1800mm
H: 150mm
Thickness:
40mm

MOQ: Minimum
order quantity is 3
pcs in each colour.

PERFORMANCE

- Fire Rates: B, S1, d0 (EN-13501)
- Light fastness: 6+ (ISO-105 B02)
- Health : 99.9 %
- Antibacterial (ISO-20743)
- Formaldehyde-free (ISO-14184)
- Moisture Absorption: >0.03 % by weight (50°C/122°F at 90% relative humidity)
- Thermal insulating: 0,040 W/mK
- Abrasion: EN ISO 12947 / Performance 'A'

KEY FEATURES & BENEFITS

- Available in 7 Natural colors & 34 Mandarin colors.
- Highly durable providing long-term stability and performance.
- Safe, non-toxic, non-irritant & without red list chemical binders.
- Recycled and recyclable.
- 10 years warranty.

CARE

- Easy to clean with a damp cloth or vacuum cleaner.
- Indoor use only.

INSTALLATION

- Designed for easy assembly free hanging installation method with adjustable ceiling mount units.

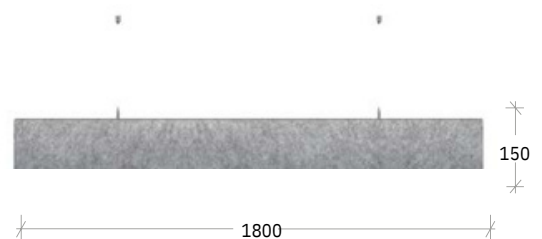
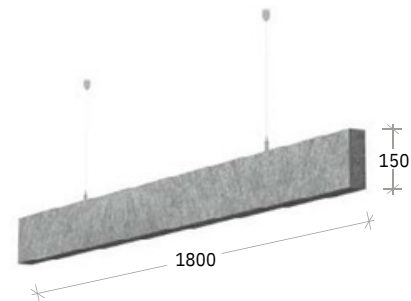

HEAD OFFICE

Westward House, Camberley, GU15 3DB | T: +44 (0) 1276 686175 | E: info@nogreyarea.co.uk

MENA REGION HQ

PO Box 449839, Dubai, UAE | T: +971 (0) 433 38300 | E: info@nogreyarea.me | www.no-grey-area.com

NGA

AIR-FELT BAFFLE 1800x150x50

Baffle Collection

Feltra models are easy to install, lightweight, and can be installed quickly to transform large volumes into linear ceiling systems. Baffle delivers tailor-made acoustic solutions that offer an adjustable gap between felt baffles and various dimensions. On request, it allows different thickness options and customizable designs.

SPECIFICATION

- Composition: 100 % polyester (recycled PET appx. 50 %)
- Material Weight: 6mm: 1300g /m² (+/- 5 %)
- Material Thickness: 6mm Natural & Mandarin colors (+/- 10 %)
- Product Weight: Natural: kg per pcs. (+/- %5)
Mandarin: kg per pcs. (+/- %5)

DIMENSIONS (MM):

L: 1800mm
H: 150mm
Thickness:
50mm

MOQ: Minimum order quantity is 3 pcs in each colour.

PERFORMANCE

- Fire Rates: B, S1, d0 (EN-13501)
- Light fastness: 6+ (ISO-105 B02)
- Health : 99.9 %
- Antibacterial (ISO-20743)
- Formaldehyde-free (ISO-14184)
- Moisture Absorption: >0.03 % by weight (50°C/122°F at 90% relative humidity)
- Thermal insulating: 0,040 W/mK
- Abrasion: EN ISO 12947 / Performance 'A'

KEY FEATURES & BENEFITS

- Available in 7 Natural colors & 34 Mandarin colors.
- Highly durable providing long-term stability and performance.
- Safe, non-toxic, non-irritant & without red list chemical binders.
- Recycled and recyclable.
- 10 years warranty.

CARE

- Easy to clean with a damp cloth or vacuum cleaner.
- Indoor use only.

INSTALLATION

- Designed for easy assembly free hanging installation method with adjustable ceiling mount units.

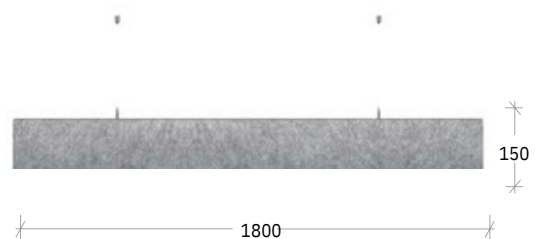
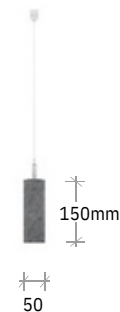
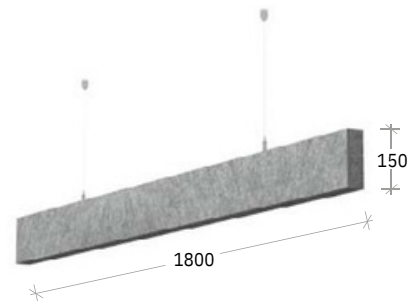

HEAD OFFICE

Westward House, Camberley, GU15 3DB | T: +44 (0) 1276 686175 | E: info@nogreyarea.co.uk

MENA REGION HQ

PO Box 449839, Dubai, UAE | T: +971 (0) 433 38300 | E: info@nogreyarea.me | www.no-grey-area.com

NGA

AIR-FELT BAFFLE 1800x200x30

Baffle Collection

Feltra models are easy to install, lightweight, and can be installed quickly to transform large volumes into linear ceiling systems. Baffle delivers tailor-made acoustic solutions that offer an adjustable gap between felt baffles and various dimensions. On request, it allows different thickness options and customizable designs.

SPECIFICATION

- Composition: 100 % polyester (recycled PET appx. 50 %)
- Material Weight: 6mm: 1300g /m² (+/- 5 %)
- Material Thickness: 6mm Natural & Mandarin colors (+/- 10 %)
- Product Weight: Natural: kg per pcs. (+/- %5)
Mandarin: kg per pcs. (+/- %5)

PERFORMANCE

- Fire Rates: B, S1, d0 (EN-13501)
- Light fastness: 6+ (ISO-105 B02)
- Health : 99.9 %
- Antibacterial (ISO-20743)
- Formaldehyde-free (ISO-14184)
- Moisture Absorption: >0.03 % by weight (50°C/122°F at 90% relative humidity)
- Thermal insulating: 0,040 W/mK
- Abrasion: EN ISO 12947 / Performance 'A'

KEY FEATURES & BENEFITS

- Available in 7 Natural colors & 34 Mandarin colors.
- Highly durable providing long-term stability and performance.
- Safe, non-toxic, non-irritant & without red list chemical binders.
- Recycled and recyclable.
- 10 years warranty.

CARE

- Easy to clean with a damp cloth or vacuum cleaner.
- Indoor use only.

INSTALLATION

- Designed for easy assembly free hanging installation method with adjustable ceiling mount units.

DIMENSIONS (MM):

L: 1800mm
H: 200mm
Thickness:
30mm

MOQ: Minimum
order quantity is 3
pcs in each colour.

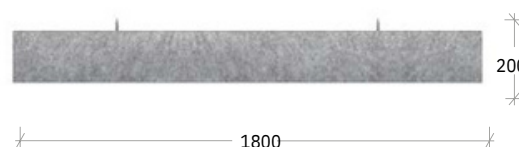
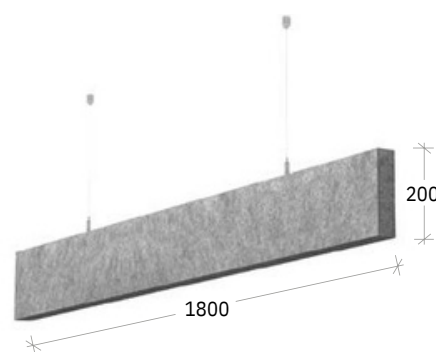

HEAD OFFICE

Westward House, Camberley, GU15 3DB | T: +44 (0) 1276 686175 | E: info@nogreyarea.co.uk

MENA REGION HQ

PO Box 449839, Dubai, UAE | T: +971 (0) 433 38300 | E: info@nogreyarea.me | www.no-grey-area.com

NGA

AIR-FELT BAFFLE 1800x200x40

Baffle Collection

Feltra models are easy to install, lightweight, and can be installed quickly to transform large volumes into linear ceiling systems. Baffle delivers tailor-made acoustic solutions that offer an adjustable gap between felt baffles and various dimensions. On request, it allows different thickness options and customizable designs.

SPECIFICATION

- Composition: 100 % polyester (recycled PET appx. 50 %)
- Material Weight: 6mm: 1300g /m² (+/- 5 %)
- Material Thickness: 6mm Natural & Mandarin colors (+/- 10 %)
- Product Weight: Natural: kg per pcs. (+/- %5)
Mandarin: kg per pcs. (+/- %5)

PERFORMANCE

- Fire Rates: B, S1, d0 (EN-13501)
- Light fastness: 6+ (ISO-105 B02)
- Health : 99.9 %
- Antibacterial (ISO-20743)
- Formaldehyde-free (ISO-14184)
- Moisture Absorption: >0.03 % by weight (50°C/122°F at 90% relative humidity)
- Thermal insulating: 0,040 W/mK
- Abrasion: EN ISO 12947 / Performance 'A'

KEY FEATURES & BENEFITS

- Available in 7 Natural colors & 34 Mandarin colors.
- Highly durable providing long-term stability and performance.
- Safe, non-toxic, non-irritant & without red list chemical binders.
- Recycled and recyclable.
- 10 years warranty.

CARE

- Easy to clean with a damp cloth or vacuum cleaner.
- Indoor use only.

INSTALLATION

- Designed for easy assembly free hanging installation method with adjustable ceiling mount units.

DIMENSIONS (MM):

L: 1800mm
H: 200mm
Thickness:
40mm

MOQ: Minimum
order quantity is 3
pcs in each colour.

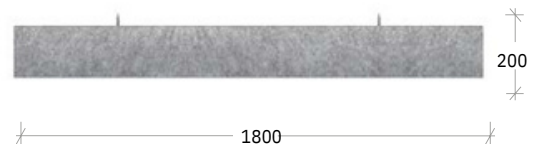
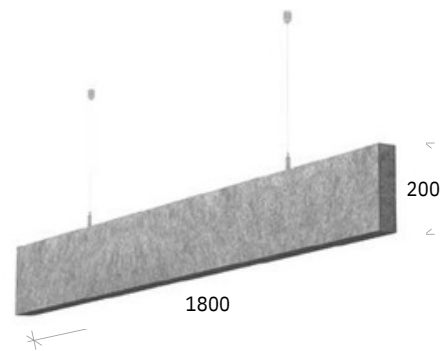

HEAD OFFICE

Westward House, Camberley, GU15 3DB | T: +44 (0) 1276 686175 | E: info@nogreyarea.co.uk

MENA REGION HQ

PO Box 449839, Dubai, UAE | T: +971 (0) 433 38300 | E: info@nogreyarea.me | www.no-grey-area.com

NGA

AIR-FELT BAFFLE 1800x200x50

Baffle Collection

Feltra models are easy to install, lightweight, and can be installed quickly to transform large volumes into linear ceiling systems. Baffle delivers tailor-made acoustic solutions that offer an adjustable gap between felt baffles and various dimensions. On request, it allows different thickness options and customizable designs.

SPECIFICATION

- Composition: 100 % polyester (recycled PET appx. 50 %)
- Material Weight: 6mm: 1300g /m² (+/- 5 %)
- Material Thickness: 6mm Natural & Mandarin colors (+/- 10 %)
- Product Weight: Natural: kg per pcs. (+/- %5)
Mandarin: kg per pcs. (+/- %5)

DIMENSIONS (MM):

L: 1800mm
H: 200mm
Thickness: 50mm

MOQ: Minimum order quantity is 3 pcs in each colour.

PERFORMANCE

- Fire Rates: B, S1, d0 (EN-13501)
- Light fastness: 6+ (ISO-105 B02)
- Health : 99.9 %
- Antibacterial (ISO-20743)
- Formaldehyde-free (ISO-14184)
- Moisture Absorption: >0.03 % by weight (50°C/122°F at 90% relative humidity)
- Thermal insulating: 0,040 W/mK
- Abrasion: EN ISO 12947 / Performance 'A'

KEY FEATURES & BENEFITS

- Available in 7 Natural colors & 34 Mandarin colors.
- Highly durable providing long-term stability and performance.
- Safe, non-toxic, non-irritant & without red list chemical binders.
- Recycled and recyclable.
- 10 years warranty.

CARE

- Easy to clean with a damp cloth or vacuum cleaner.
- Indoor use only.

INSTALLATION

- Designed for easy assembly free hanging installation method with adjustable ceiling mount units.

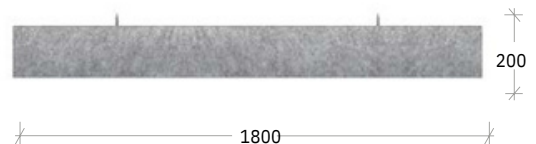
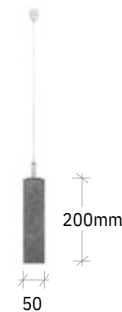
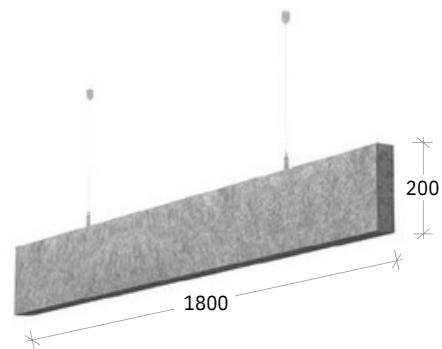

HEAD OFFICE

Westward House, Camberley, GU15 3DB | T: +44 (0) 1276 686175 | E: info@nogreyarea.co.uk

MENA REGION HQ

PO Box 449839, Dubai, UAE | T: +971 (0) 433 38300 | E: info@nogreyarea.me | www.no-grey-area.com

NGA

AIR-FELT BAFFLE 1800x300x30

Baffle Collection

Feltra models are easy to install, lightweight, and can be installed quickly to transform large volumes into linear ceiling systems. Baffle delivers tailor-made acoustic solutions that offer an adjustable gap between felt baffles and various dimensions. On request, it allows different thickness options and customizable designs.

SPECIFICATION

- Composition: 100 % polyester (recycled PET appx. 50 %)
- Material Weight: 6mm: 1300g /m² (+/- 5 %)
- Material Thickness: 6mm Natural & Mandarin colors (+/- 10 %)
- Product Weight: Natural: kg per pcs. (+/- %5)
Mandarin: kg per pcs. (+/- %5)

DIMENSIONS (MM):

L: 1800mm
H: 300mm
Thickness:
30mm

MOQ: Minimum
order quantity is 2
pcs in each colour.

PERFORMANCE

- Fire Rates: B, S1, d0 (EN-13501)
- Light fastness: 6+ (ISO-105 B02)
- Health : 99.9 %
- Antibacterial (ISO-20743)
- Formaldehyde-free (ISO-14184)
- Moisture Absorption: >0.03 % by weight (50°C/122°F at 90% relative humidity)
- Thermal insulating: 0,040 W/mK
- Abrasion: EN ISO 12947 / Performance 'A'

KEY FEATURES & BENEFITS

- Available in 7 Natural colors & 34 Mandarin colors.
- Highly durable providing long-term stability and performance.
- Safe, non-toxic, non-irritant & without red list chemical binders.
- Recycled and recyclable.
- 10 years warranty.

CARE

- Easy to clean with a damp cloth or vacuum cleaner.
- Indoor use only.

INSTALLATION

- Designed for easy assembly free hanging installation method with adjustable ceiling mount units.

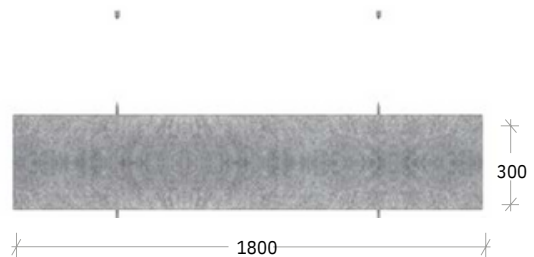
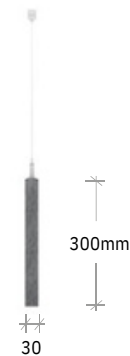
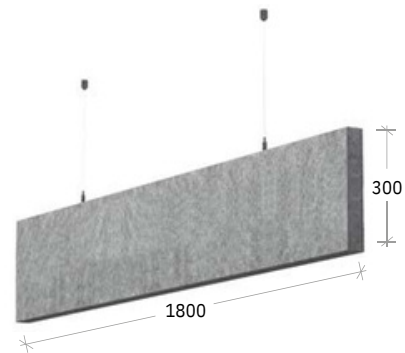

HEAD OFFICE

Westward House, Camberley, GU15 3DB | T: +44 (0) 1276 686175 | E: info@nogreyarea.co.uk

MENA REGION HQ

PO Box 449839, Dubai, UAE | T: +971 (0) 433 38300 | E: info@nogreyarea.me | www.no-grey-area.com

NGA

AIR-FELT BAFFLE 1800x300x40

Baffle Collection

Feltra models are easy to install, lightweight, and can be installed quickly to transform large volumes into linear ceiling systems. Baffle delivers tailor-made acoustic solutions that offer an adjustable gap between felt baffles and various dimensions. On request, it allows different thickness options and customizable designs.

SPECIFICATION

- Composition: 100 % polyester (recycled PET appx. 50 %)
- Material Weight: 6mm: 1300g /m² (+/- 5 %)
- Material Thickness: 6mm Natural & Mandarin colors (+/- 10 %)
- Product Weight: Natural: kg per pcs. (+/- %5)
Mandarin: kg per pcs. (+/- %5)

DIMENSIONS (MM):

L: 1800mm
H: 300mm
Thickness: 40mm

MOQ: Minimum order quantity is 2 pcs in each colour.

PERFORMANCE

- Fire Rates: B, S1, d0 (EN-13501)
- Light fastness: 6+ (ISO-105 B02)
- Health : 99.9 %
- Antibacterial (ISO-20743)
- Formaldehyde-free (ISO-14184)
- Moisture Absorption: >0.03 % by weight (50°C/122°F at 90% relative humidity)
- Thermal insulating: 0,040 W/mK
- Abrasion: EN ISO 12947 / Performance 'A'

KEY FEATURES & BENEFITS

- Available in 7 Natural colors & 34 Mandarin colors.
- Highly durable providing long-term stability and performance.
- Safe, non-toxic, non-irritant & without red list chemical binders.
- Recycled and recyclable.
- 10 years warranty.

CARE

- Easy to clean with a damp cloth or vacuum cleaner.
- Indoor use only.

INSTALLATION

- Designed for easy assembly free hanging installation method with adjustable ceiling mount units.

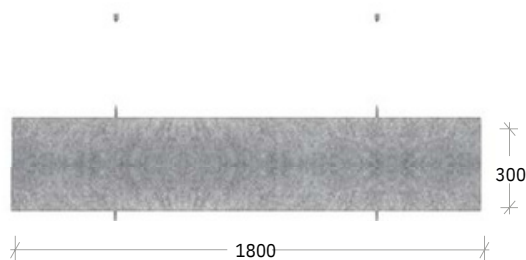
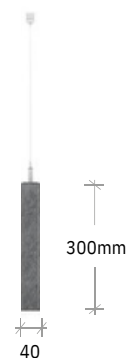
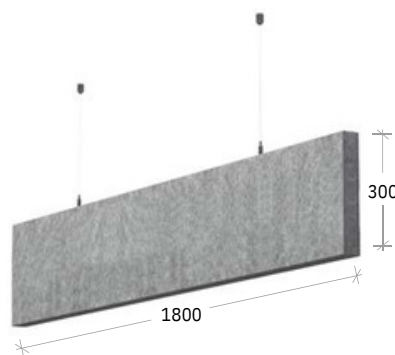

HEAD OFFICE

Westward House, Camberley, GU15 3DB | T: +44 (0) 1276 686175 | E: info@nogreyarea.co.uk

MENA REGION HQ

PO Box 449839, Dubai, UAE | T: +971 (0) 433 38300 | E: info@nogreyarea.me | www.no-grey-area.com

NGA

AIR-FELT BAFFLE 1800x300x50

Baffle Collection

Feltra models are easy to install, lightweight, and can be installed quickly to transform large volumes into linear ceiling systems. Baffle delivers tailor-made acoustic solutions that offer an adjustable gap between felt baffles and various dimensions. On request, it allows different thickness options and customizable designs.

SPECIFICATION

- Composition: 100 % polyester (recycled PET appx. 50 %)
- Material Weight: 6mm: 1300g /m² (+/- 5 %)
- Material Thickness: 6mm Natural & Mandarin colors (+/- 10 %)
- Product Weight: Natural: kg per pcs. (+/- %5)
Mandarin: kg per pcs. (+/- %5)

DIMENSIONS (MM):

L: 1800mm
H: 300mm
Thickness:
50mm

MOQ: Minimum
order quantity is 2
pcs in each colour.

PERFORMANCE

- Fire Rates: B, S1, d0 (EN-13501)
- Light fastness: 6+ (ISO-105 B02)
- Health : 99.9 %
- Antibacterial (ISO-20743)
- Formaldehyde-free (ISO-14184)
- Moisture Absorption: >0.03 % by weight (50°C/122°F at 90% relative humidity)
- Thermal insulating: 0,040 W/mK
- Abrasion: EN ISO 12947 / Performance 'A'

KEY FEATURES & BENEFITS

- Available in 7 Natural colors & 34 Mandarin colors.
- Highly durable providing long-term stability and performance.
- Safe, non-toxic, non-irritant & without red list chemical binders.
- Recycled and recyclable.
- 10 years warranty.

CARE

- Easy to clean with a damp cloth or vacuum cleaner.
- Indoor use only.

INSTALLATION

- Designed for easy assembly free hanging installation method with adjustable ceiling mount units.

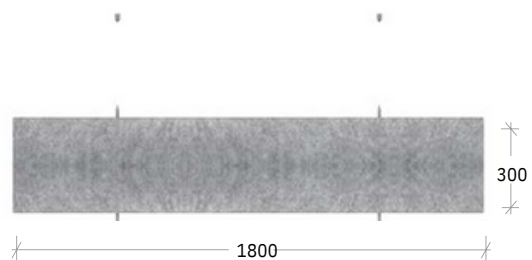
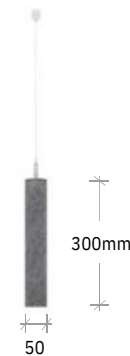
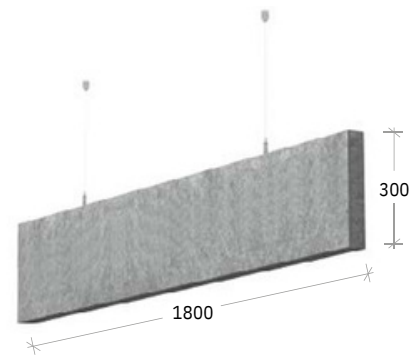

HEAD OFFICE

Westward House, Camberley, GU15 3DB | T: +44 (0) 1276 686175 | E: info@nogreyarea.co.uk

MENA REGION HQ

PO Box 449839, Dubai, UAE | T: +971 (0) 433 38300 | E: info@nogreyarea.me | www.no-grey-area.com

NGA

AIR-FELT BAFFLE 2400x150x30

Feltra models are easy to install, lightweight, and can be installed quickly to transform large volumes into linear ceiling systems. Baffle delivers tailor-made acoustic solutions that offer an adjustable gap between felt baffles and various dimensions. On request, it allows different thickness options and customizable designs.

SPECIFICATION

- Composition: 100 % polyester (recycled PET appx. 50 %)
- Material Weight: 6mm: 1300g /m² (+/- 5 %)
- Material Thickness: 6mm Natural & Mandarin colors (+/- 10 %)
- Product Weight: Natural: kg per pcs. (+/- %5)
Mandarin: kg per pcs. (+/- %5)

DIMENSIONS (MM):

L: 2400mm MOQ: Minimum order H:
150mm quantity is 4 pcs in Thickness:
30mmeach colour.

PERFORMANCE

- Fire Rates: B, S1, d0 (EN-13501)
- Light fastness: 6+ (ISO-105 B02)
- Health : 99.9 %
- Antibacterial (ISO-20743)
- Formaldehyde-free (ISO-14184)
- Moisture Absorption: >0.03 % by weight (50°C/122°F at 90% relative humidity)
- Thermal insulating: 0,040 W/mK
- Abrasion: EN ISO 12947 / Performance 'A'

KEY FEATURES & BENEFITS

- Available in 7 Natural colors & 34 Mandarin colors.
- Highly durable providing long-term stability and performance.
- Safe, non-toxic, non-irritant & without red list chemical binders.
- Recycled and recyclable.
- 10 years warranty.

CARE

- Easy to clean with a damp cloth or vacuum cleaner.
- Indoor use only.

INSTALLATION

- Designed for easy assembly free hanging installation method with adjustable ceiling mount units.

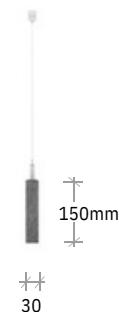
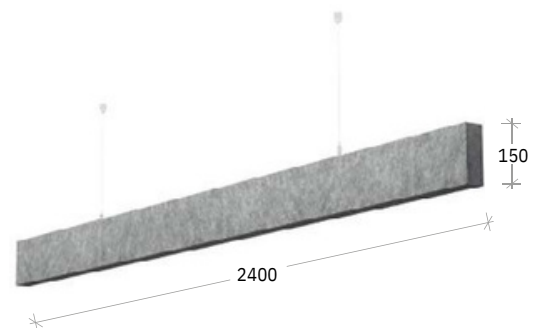

HEAD OFFICE

Westward House, Camberley, GU15 3DB | T: +44 (0) 1276 686175 | E: info@nogreyarea.co.uk

MENA REGION HQ

PO Box 449839, Dubai, UAE | T: +971 (0) 433 38300 | E: info@nogreyarea.me | www.no-grey-area.com

NGA

AIR-FELT BAFFLE 2400x150x40

Baffle Collection

Feltra models are easy to install, lightweight, and can be installed quickly to transform large volumes into linear ceiling systems. Baffle delivers tailor-made acoustic solutions that offer an adjustable gap between felt baffles and various dimensions. On request, it allows different thickness options and customizable designs.

SPECIFICATION

- Composition: 100 % polyester (recycled PET appx. 50 %)
- Material Weight: 6mm: 1300g /m² (+/- 5 %)
- Material Thickness: 6mm Natural & Mandarin colors (+/- 10 %)
- Product Weight: Natural: kg per pcs. (+/- %5)
Mandarin: kg per pcs. (+/- %5)

DIMENSIONS (MM):

L: 2400mm
MOQ: Minimum order H:
150mm
quantity is 4 pcs in Thickness:
40mm each colour.

PERFORMANCE

- Fire Rates: B, S1, d0 (EN-13501)
- Light fastness: 6+ (ISO-105 B02)
- Health : 99.9 %
- Antibacterial (ISO-20743)
- Formaldehyde-free (ISO-14184)
- Moisture Absorption: >0.03 % by weight (50°C/122°F at 90% relative humidity)
- Thermal insulating: 0,040 W/mK
- Abrasion: EN ISO 12947 / Performance 'A'

KEY FEATURES & BENEFITS

- Available in 7 Natural colors & 34 Mandarin colors.
- Highly durable providing long-term stability and performance.
- Safe, non-toxic, non-irritant & without red list chemical binders.
- Recycled and recyclable.
- 10 years warranty.

CARE

- Easy to clean with a damp cloth or vacuum cleaner.
- Indoor use only.

INSTALLATION

- Designed for easy assembly free hanging installation method with adjustable ceiling mount units.

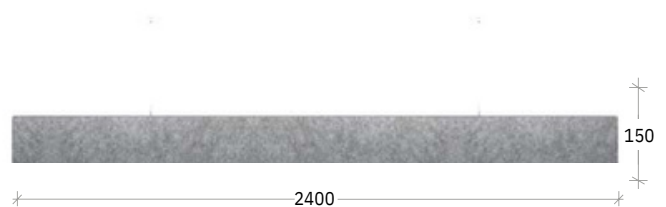
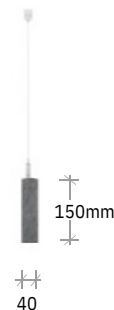
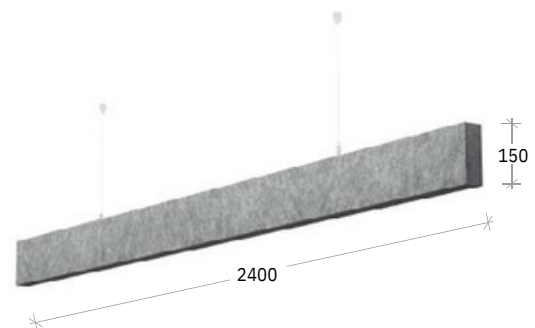

HEAD OFFICE

Westward House, Camberley, GU15 3DB | T: +44 (0) 1276 686175 | E: info@nogreyarea.co.uk

MENA REGION HQ

PO Box 449839, Dubai, UAE | T: +971 (0) 433 38300 | E: info@nogreyarea.me | www.no-grey-area.com

NGA

AIR-FELT BAFFLE 2400x150x50

Baffle Collection

Feltra models are easy to install, lightweight, and can be installed quickly to transform large volumes into linear ceiling systems. Baffle delivers tailor-made acoustic solutions that offer an adjustable gap between felt baffles and various dimensions. On request, it allows different thickness options and customizable designs.

SPECIFICATION

- Composition: 100 % polyester (recycled PET appx. 50 %)
- Material Weight: 6mm: 1300g /m² (+/- 5 %)
- Material Thickness: 6mm Natural & Mandarin colors (+/- 10 %)
- Product Weight: Natural: kg per pcs. (+/- %5)
Mandarin: kg per pcs. (+/- %5)

DIMENSIONS (MM):

L: 2400mm
H: 150mm
Thickness:
50mm

MOQ: Minimum
order quantity is 3
pcs in each colour.

PERFORMANCE

- Fire Rates: B, S1, d0 (EN-13501)
- Light fastness: 6+ (ISO-105 B02)
- Health : 99.9 %
- Antibacterial (ISO-20743)
- Formaldehyde-free (ISO-14184)
- Moisture Absorption: >0.03 % by weight (50°C/122°F at 90% relative humidity)
- Thermal insulating: 0,040 W/mK
- Abrasion: EN ISO 12947 / Performance 'A'

KEY FEATURES & BENEFITS

- Available in 7 Natural colors & 34 Mandarin colors.
- Highly durable providing long-term stability and performance.
- Safe, non-toxic, non-irritant & without red list chemical binders.
- Recycled and recyclable.
- 10 years warranty.

CARE

- Easy to clean with a damp cloth or vacuum cleaner.
- Indoor use only.

INSTALLATION

- Designed for easy assembly free hanging installation method with adjustable ceiling mount units.

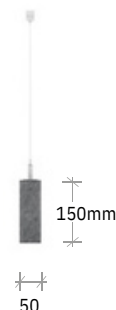
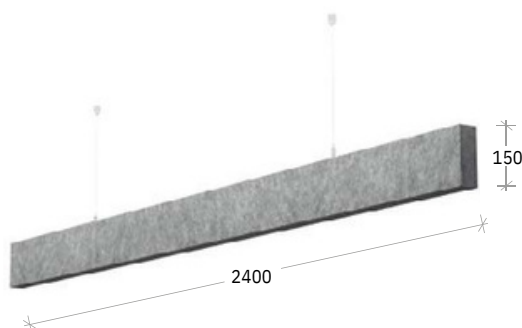

HEAD OFFICE

Westward House, Camberley, GU15 3DB | T: +44 (0) 1276 686175 | E: info@nogreyarea.co.uk

MENA REGION HQ

PO Box 449839, Dubai, UAE | T: +971 (0) 433 38300 | E: info@nogreyarea.me | www.no-grey-area.com

NGA

AIR-FELT BAFFLE 2400x200x30

Baffle Collection

Feltra models are easy to install, lightweight, and can be installed quickly to transform large volumes into linear ceiling systems. Baffle delivers tailor-made acoustic solutions that offer an adjustable gap between felt baffles and various dimensions. On request, it allows different thickness options and customizable designs.

SPECIFICATION

- Composition: 100 % polyester (recycled PET appx. 50 %)
- Material Weight: 6mm: 1300g /m² (+/- 5 %)
- Material Thickness: 6mm Natural & Mandarin colors (+/- 10 %)
- Product Weight: Natural: kg per pcs. (+/- %5)
Mandarin: kg per pcs. (+/- %5)

DIMENSIONS (MM):

L: 2400mm
H: 200mm
Thickness:
30mm

MOQ: Minimum
order quantity is 3
pcs in each colour.

PERFORMANCE

- Fire Rates: B, S1, d0 (EN-13501)
- Light fastness: 6+ (ISO-105 B02)
- Health : 99.9 %
- Antibacterial (ISO-20743)
- Formaldehyde-free (ISO-14184)
- Moisture Absorption: >0.03 % by weight (50°C/122°F at 90% relative humidity)
- Thermal insulating: 0,040 W/mK
- Abrasion: EN ISO 12947 / Performance 'A'

KEY FEATURES & BENEFITS

- Available in 7 Natural colors & 34 Mandarin colors.
- Highly durable providing long-term stability and performance.
- Safe, non-toxic, non-irritant & without red list chemical binders.
- Recycled and recyclable.
- 10 years warranty.

CARE

- Easy to clean with a damp cloth or vacuum cleaner.
- Indoor use only.

INSTALLATION

- Designed for easy assembly free hanging installation method with adjustable ceiling mount units.

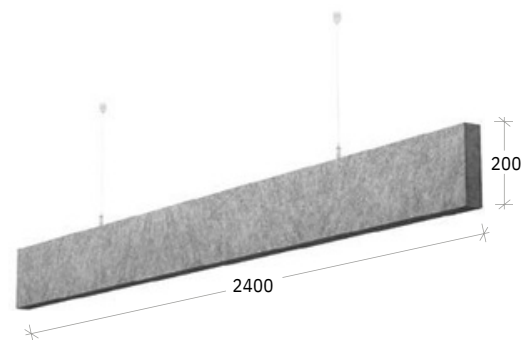

HEAD OFFICE

Westward House, Camberley, GU15 3DB | T: +44 (0) 1276 686175 | E: info@nogreyarea.co.uk

MENA REGION HQ

PO Box 449839, Dubai, UAE | T: +971 (0) 433 38300 | E: info@nogreyarea.me | www.no-grey-area.com

NGA

AIR-FELT BAFFLE 2400x200x40

Baffle Collection

Feltra models are easy to install, lightweight, and can be installed quickly to transform large volumes into linear ceiling systems. Baffle delivers tailor-made acoustic solutions that offer an adjustable gap between felt baffles and various dimensions. On request, it allows different thickness options and customizable designs.

SPECIFICATION

- Composition: 100 % polyester (recycled PET appx. 50 %)
- Material Weight: 6mm: 1300g /m² (+/- 5 %)
- Material Thickness: 6mm Natural & Mandarin colors (+/- 10 %)
- Product Weight: Natural: kg per pcs. (+/- %5)
Mandarin: kg per pcs. (+/- %5)

DIMENSIONS (MM):

L: 2400mm
H: 200mm
Thickness:
40mm

MOQ: Minimum
order quantity is 3
pcs in each colour.

PERFORMANCE

- Fire Rates: B, S1, d0 (EN-13501)
- Light fastness: 6+ (ISO-105 B02)
- Health : 99.9 %
- Antibacterial (ISO-20743)
- Formaldehyde-free (ISO-14184)
- Moisture Absorption: >0.03 % by weight (50°C/122°F at 90% relative humidity)
- Thermal insulating: 0,040 W/mK
- Abrasion: EN ISO 12947 / Performance 'A'

KEY FEATURES & BENEFITS

- Available in 7 Natural colors & 34 Mandarin colors.
- Highly durable providing long-term stability and performance.
- Safe, non-toxic, non-irritant & without red list chemical binders.
- Recycled and recyclable.
- 10 years warranty.

CARE

- Easy to clean with a damp cloth or vacuum cleaner.
- Indoor use only.

INSTALLATION

- Designed for easy assembly free hanging installation method with adjustable ceiling mount units.

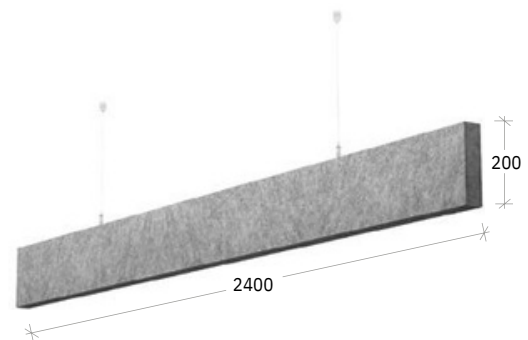

HEAD OFFICE

Westward House, Camberley, GU15 3DB | T: +44 (0) 1276 686175 | E: info@nogreyarea.co.uk

MENA REGION HQ

PO Box 449839, Dubai, UAE | T: +971 (0) 433 38300 | E: info@nogreyarea.me | www.no-grey-area.com

NGA

AIR-FELT BAFFLE 2400x200x50

Baffle Collection

Feltra models are easy to install, lightweight, and can be installed quickly to transform large volumes into linear ceiling systems. Baffle delivers tailor-made acoustic solutions that offer an adjustable gap between felt baffles and various dimensions. On request, it allows different thickness options and customizable designs.

SPECIFICATION

- Composition: 100 % polyester (recycled PET appx. 50 %)
- Material Weight: 6mm: 1300g /m² (+/- 5 %)
- Material Thickness: 6mm Natural & Mandarin colors (+/- 10 %)
- Product Weight: Natural: kg per pcs. (+/- %5)
Mandarin: kg per pcs. (+/- %5)

DIMENSIONS (MM):

L: 2400mm
H: 200mm
Thickness:
50mm

MOQ: Minimum
order quantity is 3
pcs in each colour.

PERFORMANCE

- Fire Rates: B, S1, d0 (EN-13501)
- Light fastness: 6+ (ISO-105 B02)
- Health : 99.9 %
- Antibacterial (ISO-20743)
- Formaldehyde-free (ISO-14184)
- Moisture Absorption: >0.03 % by weight (50°C/122°F at 90% relative humidity)
- Thermal insulating: 0,040 W/mK
- Abrasion: EN ISO 12947 / Performance 'A'

KEY FEATURES & BENEFITS

- Available in 7 Natural colors & 34 Mandarin colors.
- Highly durable providing long-term stability and performance.
- Safe, non-toxic, non-irritant & without red list chemical binders.
- Recycled and recyclable.
- 10 years warranty.

CARE

- Easy to clean with a damp cloth or vacuum cleaner.
- Indoor use only.

INSTALLATION

- Designed for easy assembly free hanging installation method with adjustable ceiling mount units.

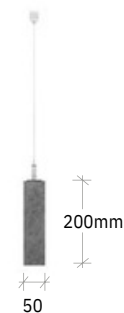
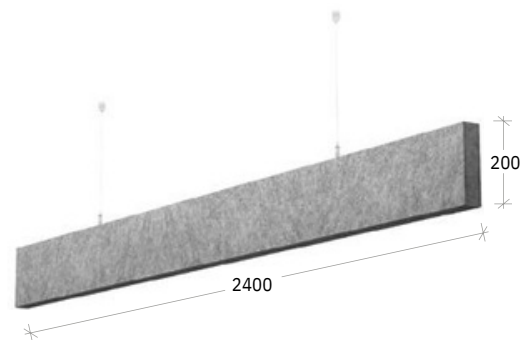

HEAD OFFICE

Westward House, Camberley, GU15 3DB | T: +44 (0) 1276 686175 | E: info@nogreyarea.co.uk

MENA REGION HQ

PO Box 449839, Dubai, UAE | T: +971 (0) 433 38300 | E: info@nogreyarea.me | www.nogrey-area.com

NGA

AIR-FELT BAFFLE 240x30x3

Baffle Collection

Feltra models are easy to install, lightweight, and can be installed quickly to transform large volumes into linear ceiling systems. Baffle delivers tailor-made acoustic solutions that offer an adjustable gap between felt baffles and various dimensions. On request, it allows different thickness options and customizable designs.

SPECIFICATION

- Composition: 100 % polyester (recycled PET appx. 50 %)
- Material Weight: 6mm: 1300g /m² (+/- 5 %)
- Material Thickness: 6mm Natural & Mandarin colors (+/- 10 %)
- Product Weight: Natural: kg per pcs. (+/- %5)
Mandarin: kg per pcs. (+/- %5)

DIMENSIONS (MM):

L: 2400mm
H: 300mm
Thickness:
30mm

MOQ: Minimum
order quantity is 2
pcs in each colour.

PERFORMANCE

- Fire Rates: B, S1, d0 (EN-13501)
- Light fastness: 6+ (ISO-105 B02)
- Health : 99.9 %
- Antibacterial (ISO-20743)
- Formaldehyde-free (ISO-14184)
- Moisture Absorption: >0.03 % by weight (50°C/122°F at 90% relative humidity)
- Thermal insulating: 0,040 W/mK
- Abrasion: EN ISO 12947 / Performance 'A'

KEY FEATURES & BENEFITS

- Available in 7 Natural colors & 34 Mandarin colors.
- Highly durable providing long-term stability and performance.
- Safe, non-toxic, non-irritant & without red list chemical binders.
- Recycled and recyclable.
- 10 years warranty.

CARE

- Easy to clean with a damp cloth or vacuum cleaner.
- Indoor use only.

INSTALLATION

- Designed for easy assembly free hanging installation method with adjustable ceiling mount units.

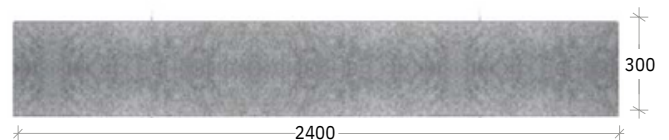
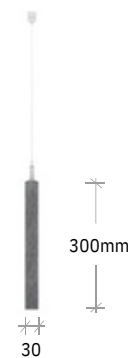
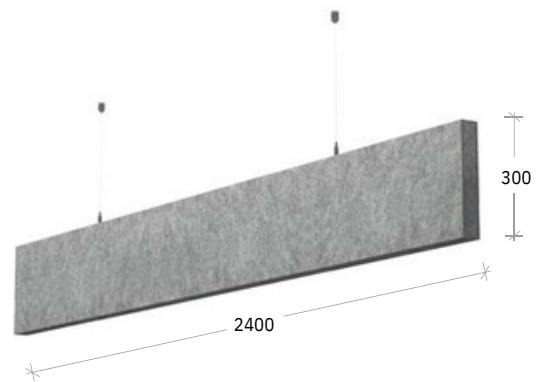

HEAD OFFICE

Westward House, Camberley, GU15 3DB | T: +44 (0) 1276 686175 | E: info@nogreyarea.co.uk

MENA REGION HQ

PO Box 449839, Dubai, UAE | T: +971 (0) 433 38300 | E: info@nogreyarea.me | www.no-grey-area.com

NGA

AIR-FELT BAFFLE 2400x300x40

Baffle Collection

Feltra models are easy to install, lightweight, and can be installed quickly to transform large volumes into linear ceiling systems. Baffle delivers tailor-made acoustic solutions that offer an adjustable gap between felt baffles and various dimensions. On request, it allows different thickness options and customizable designs.

SPECIFICATION

- Composition: 100 % polyester (recycled PET appx. 50 %)
- Material Weight: 6mm: 1300g /m² (+/- 5 %)
- Material Thickness: 6mm Natural & Mandarin colors (+/- 10 %)
- Product Weight: Natural: kg per pcs. (+/- %5)
Mandarin: kg per pcs. (+/- %5)

DIMENSIONS (MM):

L: 2400mm
H: 300mm
Thickness:
40mm

MOQ: Minimum
order quantity is 2
pcs in each colour.

PERFORMANCE

- Fire Rates: B, S1, d0 (EN-13501)
- Light fastness: 6+ (ISO-105 B02)
- Health : 99.9 %
- Antibacterial (ISO-20743)
- Formaldehyde-free (ISO-14184)
- Moisture Absorption: >0.03 % by weight (50°C/122°F at 90% relative humidity)
- Thermal insulating: 0,040 W/mK
- Abrasion: EN ISO 12947 / Performance 'A'

KEY FEATURES & BENEFITS

- Available in 7 Natural colors & 34 Mandarin colors.
- Highly durable providing long-term stability and performance.
- Safe, non-toxic, non-irritant & without red list chemical binders.
- Recycled and recyclable.
- 10 years warranty.

CARE

- Easy to clean with a damp cloth or vacuum cleaner.
- Indoor use only.

INSTALLATION

- Designed for easy assembly free hanging installation method with adjustable ceiling mount units.

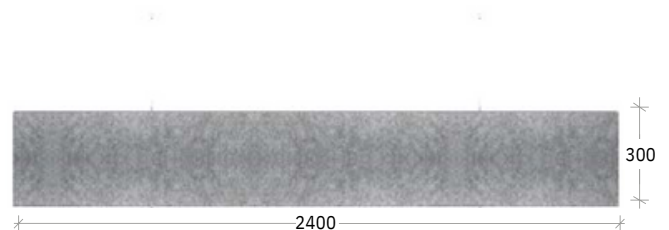
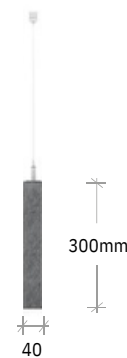
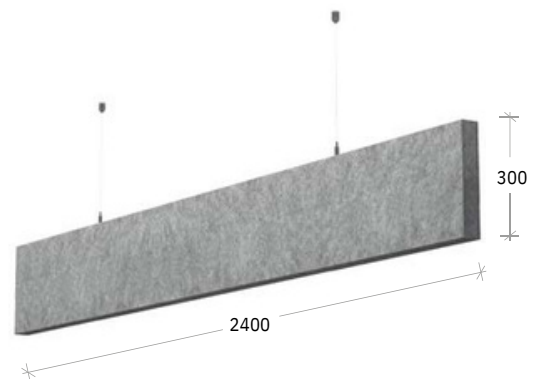

HEAD OFFICE

Westward House, Camberley, GU15 3DB | T: +44 (0) 1276 686175 | E: info@nogreyarea.co.uk

MENA REGION HQ

PO Box 449839, Dubai, UAE | T: +971 (0) 433 38300 | E: info@nogreyarea.me | www.nogrey-area.com

NGA

AIR-FELT BAFFLE 2400x300x50

Baffle Collection

Feltra models are easy to install, lightweight, and can be installed quickly to transform large volumes into linear ceiling systems. Baffle delivers tailor-made acoustic solutions that offer an adjustable gap between felt baffles and various dimensions. On request, it allows different thickness options and customizable designs.

SPECIFICATION

- Composition: 100 % polyester (recycled PET appx. 50 %)
- Material Weight: 6mm: 1300g /m² (+/- 5 %)
- Material Thickness: 6mm Natural & Mandarin colors (+/- 10 %)
- Product Weight: Natural: kg per pcs. (+/- %5)
Mandarin: kg per pcs. (+/- %5)

DIMENSIONS (MM):

L: 2400mm
H: 300mm
Thickness:
50mm

MOQ: Minimum order quantity is 2 pcs in each colour.

PERFORMANCE

- Fire Rates: B, S1, d0 (EN-13501)
- Light fastness: 6+ (ISO-105 B02)
- Health : 99.9 %
- Antibacterial (ISO-20743)
- Formaldehyde-free (ISO-14184)
- Moisture Absorption: >0.03 % by weight (50°C/122°F at 90% relative humidity)
- Thermal insulating: 0,040 W/mK
- Abrasion: EN ISO 12947 / Performance 'A'

KEY FEATURES & BENEFITS

- Available in 7 Natural colors & 34 Mandarin colors.
- Highly durable providing long-term stability and performance.
- Safe, non-toxic, non-irritant & without red list chemical binders.
- Recycled and recyclable.
- 10 years warranty.

CARE

- Easy to clean with a damp cloth or vacuum cleaner.
- Indoor use only.

INSTALLATION

- Designed for easy assembly free hanging installation method with adjustable ceiling mount units.

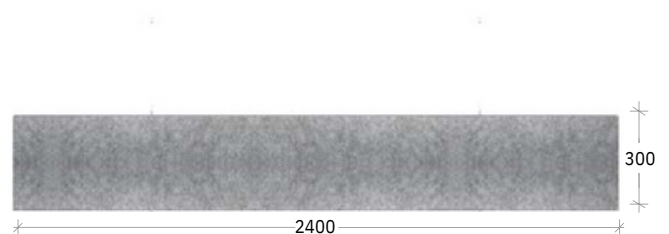
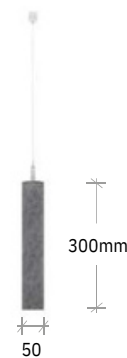
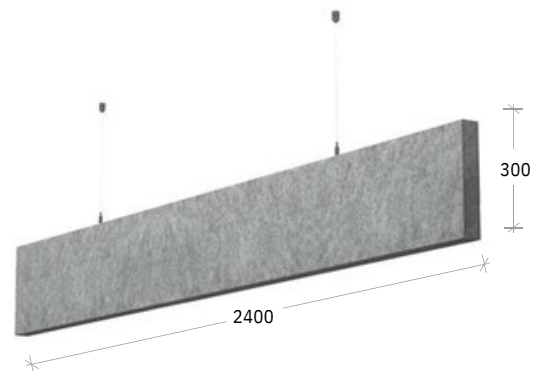

HEAD OFFICE

Westward House, Camberley, GU15 3DB | T: +44 (0) 1276 686175 | E: info@nogreyarea.co.uk

MENA REGION HQ

PO Box 449839, Dubai, UAE | T: +971 (0) 433 38300 | E: info@nogreyarea.me | www.no-grey-area.com

NGA